

ACERA

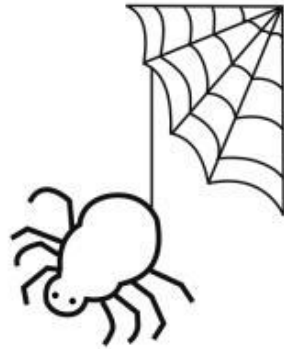

ARAÑA

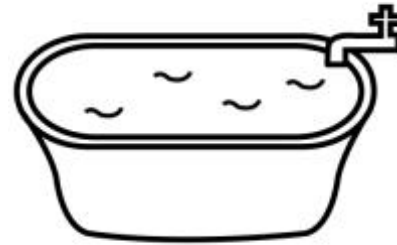

BAÑERA



BATIDORA



CAFETERA

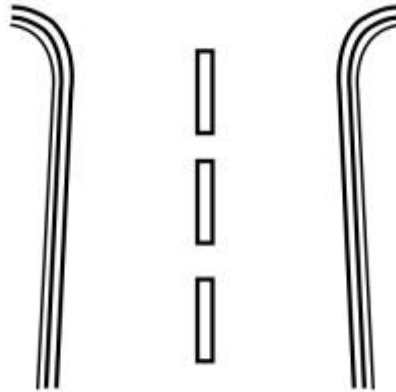

CARRETERA



CAZADORA



CUCHARA



ENFERMERA

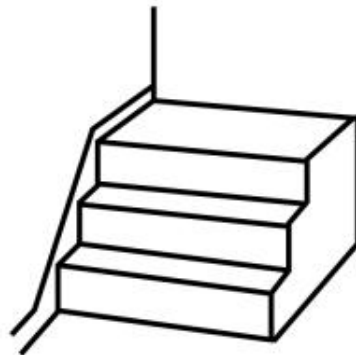

ESCALERA



JIRAFa



LLORAR

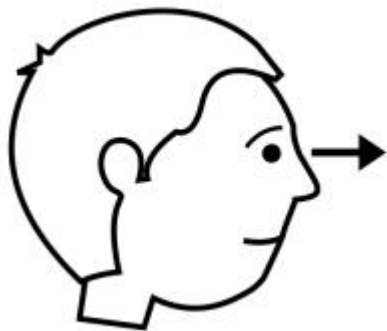

MIRAR

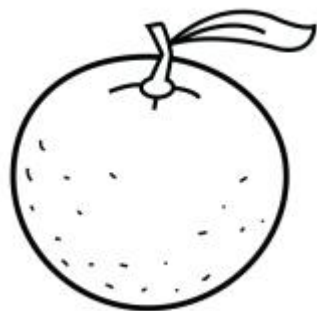

NARANJA



PAPELERA



MARACAS



PARAGUAS

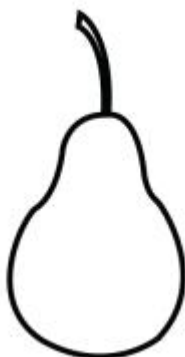

PERA



TIJERAS



ACELGAS

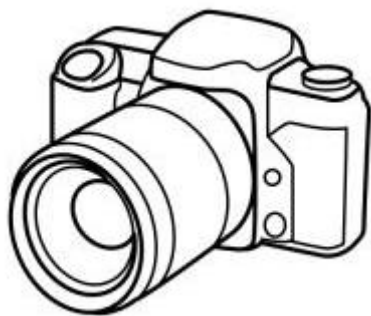

CÁMARA

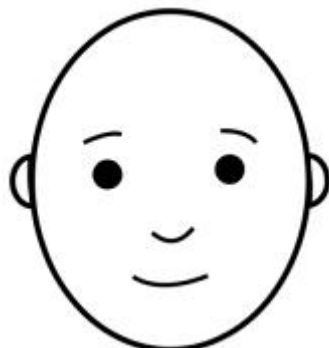

CARA



CORAL



CARACOL



CURA

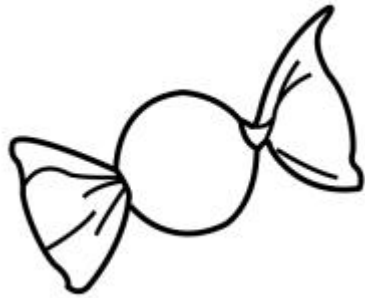

CARAMELO

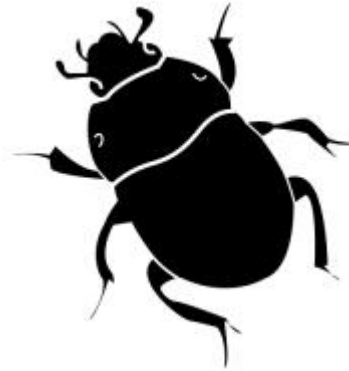

CUCARACHA

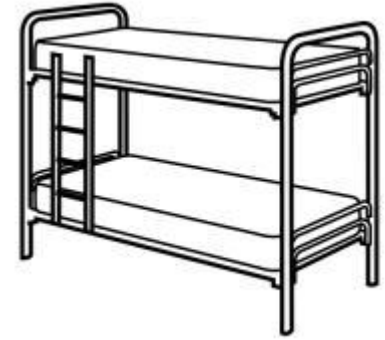

LITERA



EMBARAZADA



JARABE

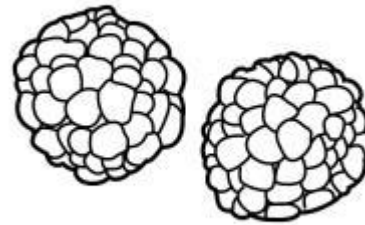

MORAS



PINTORA



CARABANA



CURAR



CAJERA



PASTELERA

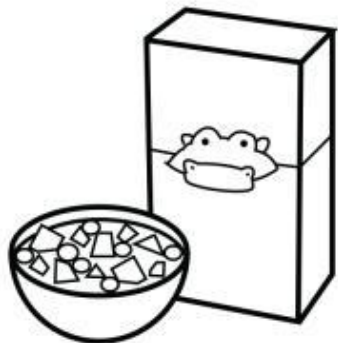

CEREALES



CEREZAS

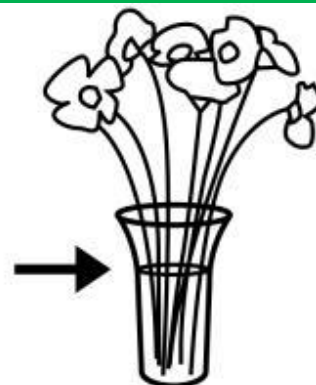

FLORERO

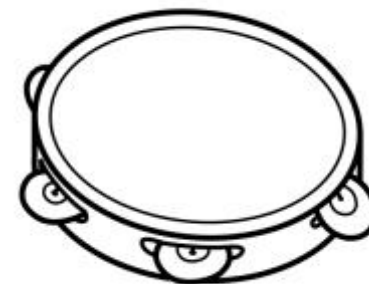

PANDERETA



MAREADO

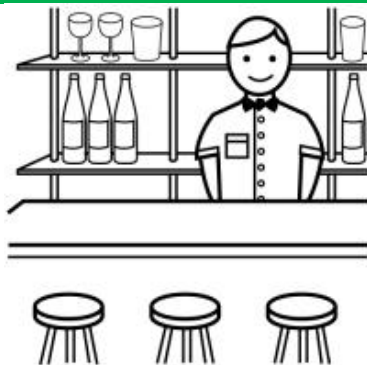

CAMARERO



TORERO



BASURERO

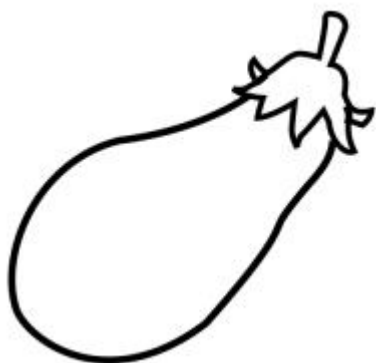

BERENJENA



AIRE



OREJA



CALAMARES

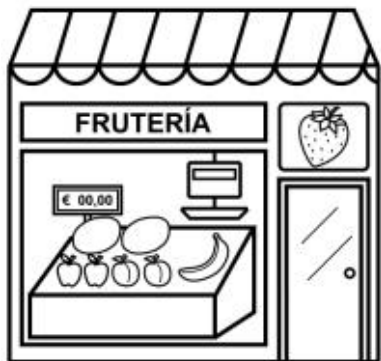

FRUTERIA



PELUQUERÍA

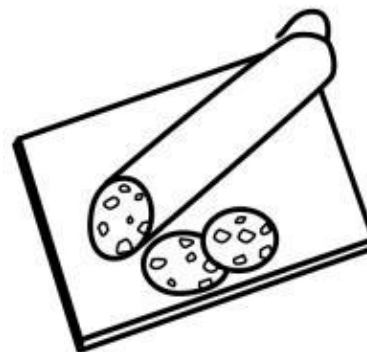

CHORIZO



MARIPOSA



PERIQUITO



ZANAHORIA



DINOSAURIO

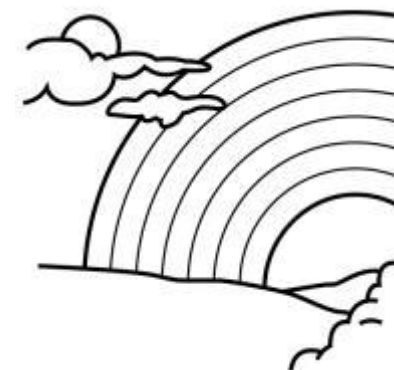

ARCO IRIS



BAILARINA

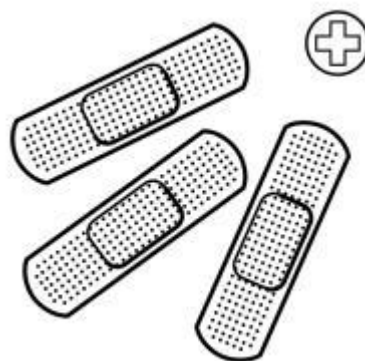

TIRITAS

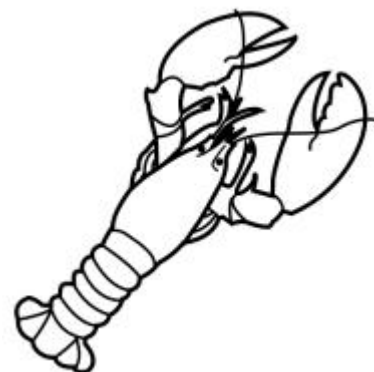

MARISCO



MARGARITA

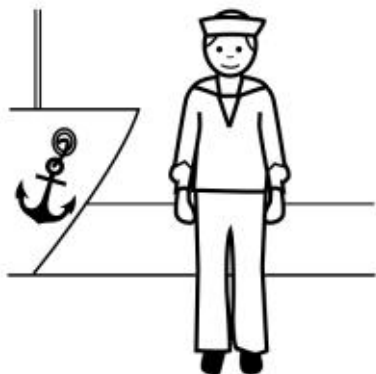

MARINERO

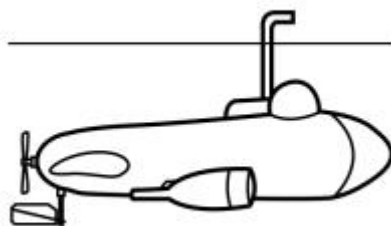

SUBMARINO



MERIENDA

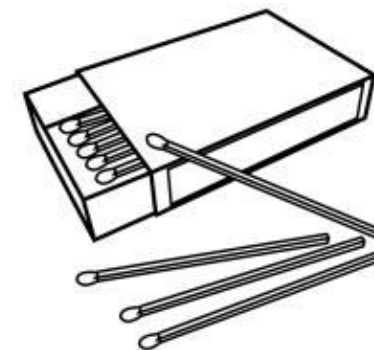

CERILLAS

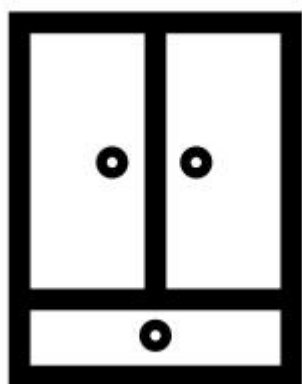

ARMARIO

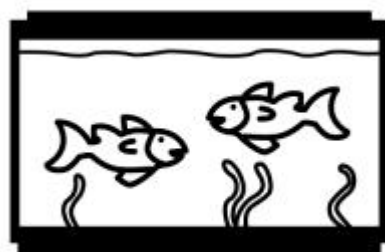

ACUARIO



ACARICIAR

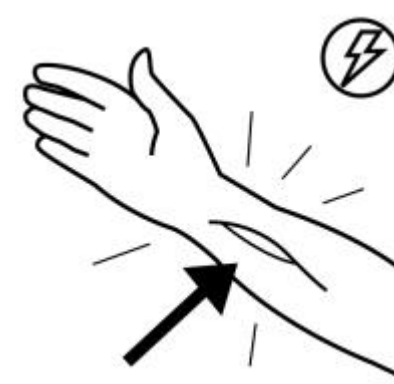

HERIDA

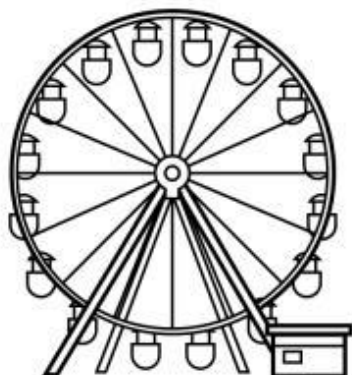

NORIA



VARITA

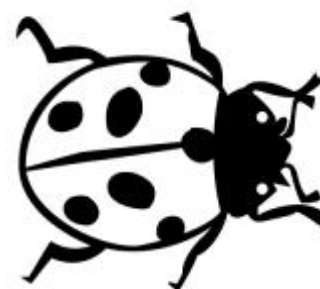

MARIQUITA

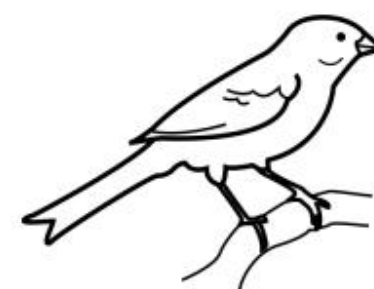

CANARIO



LAPICERO

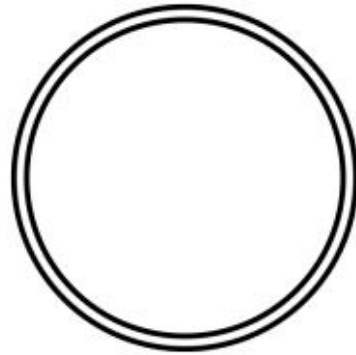

ARO



BABERO

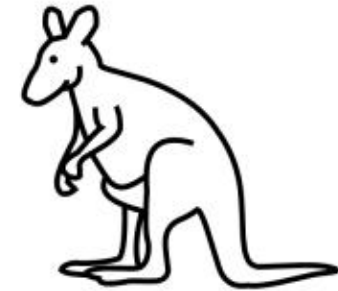

CANGURO

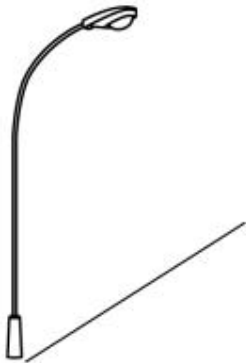

FAROLA



AZUCARERO

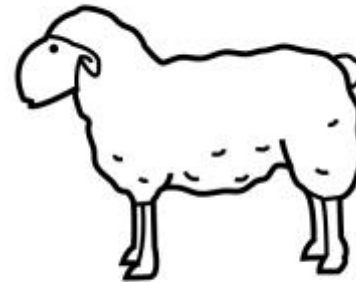

CORDERO

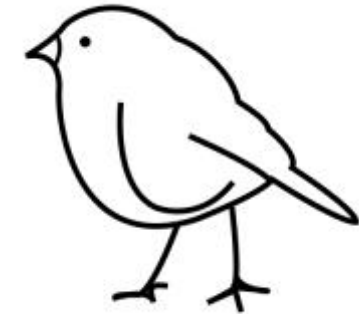

PÁJARO

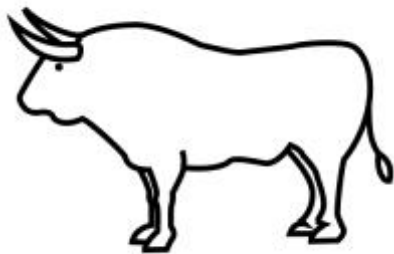

TORO



SEMÁFORO



SOMBRERO

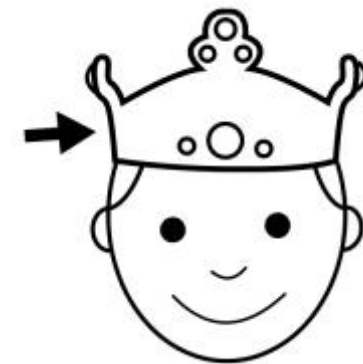

CORONA



OBRERO

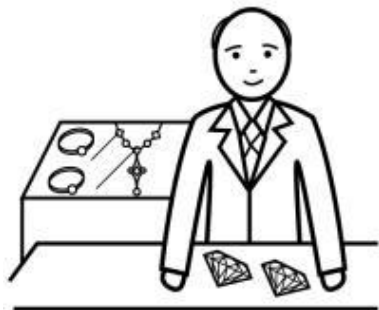

JOYERO

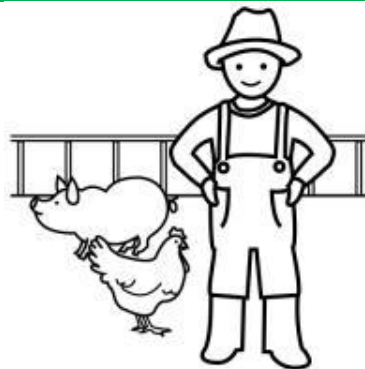

GRANJERO



CARTERO



COCINERO



BOMBERO



CARPINTERO



CARNICERO



PANADERO



ZAPATERO



FONTANERO

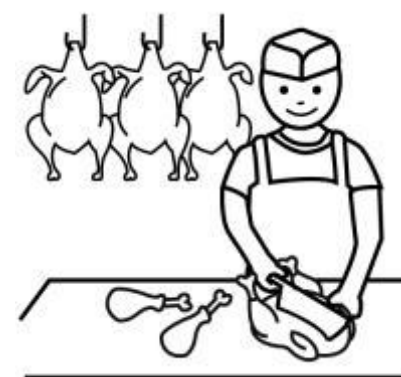

POLLERO



CENICERO

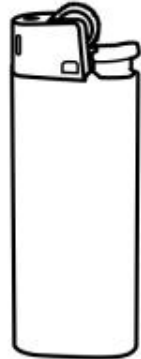

MECHERO

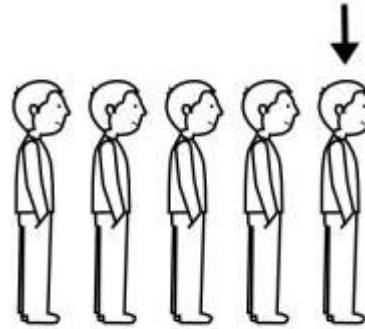

PRIMERO

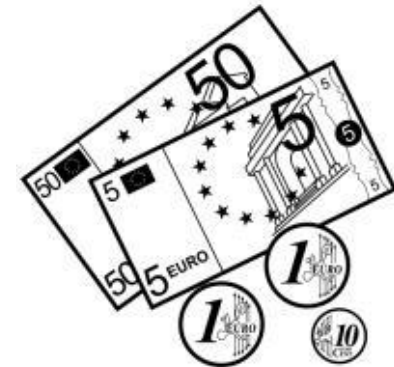

DINERO



CHUBASQUERO



MONTAÑERO



LORO



SEMÁFORO



CIRUJANO



VAMPIRO



FARO



CAPERUCITA

An underwater scene with a smiling girl with orange hair, coral, and fish. The girl is in the bottom right corner, looking up. There are several colorful fish (pink, yellow, blue) swimming around. The background is light blue with white bubbles. The title is in a white box in the center.

LOTO DE PALABRAS CON ERRE SUAVE

AUTOR DE LOS PICTOGRAMAS: SERGIO PALAU.
PROCEDENCIA: [HTTP://WWW.CATEDU.ES/ARASAAC/](http://www.catedu.es/arasaac/)
LICENCIA: CC (BY_NC)
AUTORA: JUANA Mª BAYO MARTÍNEZ .-
[HTTP://MAESTRADEAL.BLOGSPOT.COM](http://maestradeal.blogspot.com)